

SPX WAUKESHA

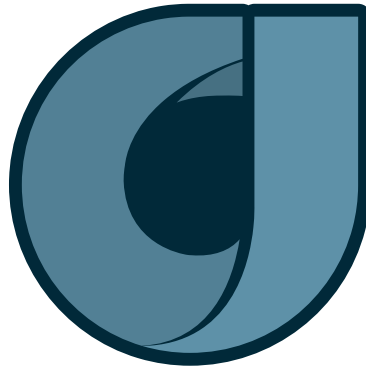

Universal I Series Pumps
Rotary Positive Displacement Pumps



COEBSA

SPX WAUKESHA

Universal II Series Pumps
Rotary Positive Displacement Pumps

New levels of sanitary performance. Long-life engineering features.

For more than half a century, Waukesha Cherry-Burrell has been a leader in the design, manufacturing and application of external circumferential, piston (ECP) style, rotary positive displacement pumps. Waukesha Cherry-Burrell PD pumps are in service around the world in food, dairy, canning, bakery, beverage and pharmaceutical processing, as well as challenging chemical and industrial applications.

Users of Waukesha Cherry-Burrell PD pumps benefit from decades of continuing product improvement. Steady advances in design, metallurgy and fabrication techniques have yielded progressively higher levels of performance and service life.

THE UNIVERSAL II SERIES of pumps is the latest expression of this tradition. They combine 3-way mounting versatility introduced by the Universal I with new features that extend pump life and improve sanitary performance. Pump is available in CIPable configurations.

New Sanitation Features

- CIP capability available. Pump body has optional internal flat body profile and will free drain with vertical ports. Optional rotor and body hub drilling provided for difficult CIP cleaning applications.
- Cover is free draining in horizontal or vertical port positions. Rotor/shaft connection sealed from product zone.
- Single mechanical seals standard. Optional double mechanical seals also available.
- Seal flush optional: seal areas interconnected to improve circulation and draining of seal flush fluid. Steam-In-Place also is optional.
- Stainless steel bearing frame optional on models 006 to 220. ▪ Aseptic Design (Option)

Long-life features

- Up to 500 (34.5 bar) psi pressure capability.
- Special rotor nut designed for extended service without loosening.
- No bearings in the product zone.
- Larger diameter 17-4 PH shafts for greater strength and stiffness. Helps eliminate vibration; extends seal life.
- Heavy duty bearing frame (stainless steel available as an option).
- Double tapered roller bearings.
- Greased lubed bearings for positive lubrication to all bearings over entire speed, temperature and pressure range.
- Body retaining screws for maintaining mechanical seal contact during inspection.
- Extended outer seal life. A wave spring, instead of an O-ring, mechanically loads the seal.
- O-Ring on inner seal, seals on clean surface as seal moves due to wear.
- Unique mechanical seal design utilizes 3 pin stationary seal and special design shaft for rotary seal.

Typical product applications

Bakery

Batters
Flavorings
Frostings
Fruit Fillings
Fats & Oils
Sweeteners
Yeast Slurry

Beverage

Beer, Wort, Yeast
Soft Drinks
Fruit Concentrates
Fruit Drinks

Canning

Baby Foods, Soups, Stews
Tomato Paste/Sauces
Fruit Puree
Vegetables, Diced, Slurries
Puddings, Jams, Jellies
Salad Dressings, Mayonnaise

Confectionery

Syrups
Cream Fillings
Chocolate

Cosmetics

Face Creams & Lotions
Hair Styling Gels & Liquids
Essential Oils
Dyes & Alcohols

Dairy

Cream, Milk, Butter
Cheese Curd & Whey
Cottage Cheese
Yogurt

Meat Packing

Meat-Emulsions
Ground Meats
Pet Foods
Ruffle & Caul Fat

Pharmaceutical

Pill Pastes
Syrups
Extracts
Emulsions
Slurries

Chemical/Industrial

Solvents
Fuels
Oils & Lubricants
Paints
Resins & Polymers
Soaps
Sludges

Installation flexibility

- Bi-directional flow. Rotors, locked with belleville washers and torqued nuts, rotate securely in either direction. No more flow direction/shaft position specifications.
- Interchangeable installation dimensions with Universal I and Universal Lobe PD pumps. (Except for 320 and 324 sizes)
- Versatile 3-Way mounting of gear case, including vertical alignment of ports.
- Upper or lower shaft position.
- Jacketed or vented cover optional.
- Exclusive, non-galling Waukesha "88" alloy rotors standard; permits running at tighter clearances and pumping a wide range of viscosities. 316 stainless steel lobe rotors also available.
- 316 stainless steel pump body and cover; 316L optional.
- Electro-polish of product contact surfaces, optional.

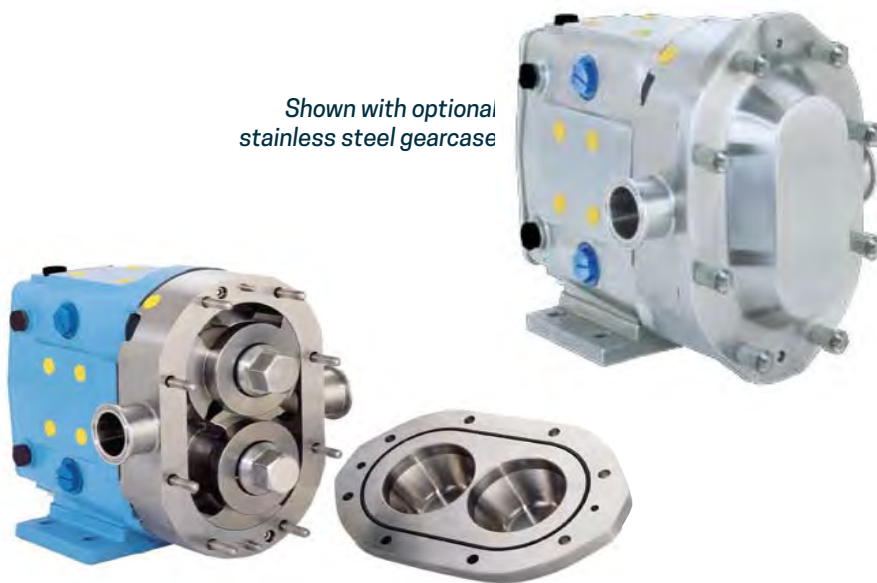

Shown with optional stainless steel gearcase

Shown with optional flat body profile

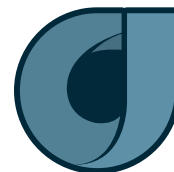

COEBSA

Specifications



Universal II Models.

MODEL	DISPLACEMENT PER REVOLUTION	NOMINAL CAPACITY* TO	INLET/ OUTLET	OPTIONAL INLET/ OUTLET	PRESSURE RANGE UP TO**	MAXIMUM RPM	TEMP RANGE**
006-U2	.0082 GAL. (.031 LITER)	8 GPM (1.8 m³/hr.)	1"	1 1/2"	300 PSI (20.7 bar)	1000	Std. Rotors: (-40 ° F/C TO 200 °F (93 °C)
015-U2	.0142 GAL. (.054 LITER)	11 GPM (2.5 m³/hr.)	1 1/2"	—	250 PSI (17.2 bar)	800	
018-U2	.029 GAL. (.110 LITER)	20 GPM (4.5 m³/hr.)	1 1/2"	2"	200 PSI (13.8 bar)	700	
030-U2	.060 GAL. (.227 LITER)	36 GPM (8.2 m³/hr.)	1 1/2"	2"	250 PSI (17.2 bar)	600	
040-U2	.076 GAL. (.228 LITER)	46 GPM (10.2 m³/hr.)	2"	—	150 PSI (10.5 bar)	600	
045-U2	.098 GAL. (.371 LITER)	58 GPM (13.2 m³/hr.)	2"	—	450 PSI (31.0 bar)	600	
060-U2	.153 GAL. (.579 LITER)	90 GPM (20.4 m³/hr.)	2 1/2"	3"	300 PSI (20.7 bar)	600	Hot Clearance Rotors: 180 °F (82 °C) TO 300 °F (149 °C)
130-U2	.253 GAL. (.958 LITER)	150 GPM (34.1 m³/hr.)	3"	—	200 PSI (13.8 bar)	600	
180-U2	.380 GAL. (1.438 LITER)	230 GPM (52.2 m³/hr.)	3"	—	450 PSI (31.0 bar)	600	
210-U2	.502 GAL. (1.900 LITER)	300 GPM (68.1 m³/hr.)	4"	—	500 PSI (34.5 bar)	600	
220-U2	.521 GAL. (1.972 LITER)	310 GPM (70.4 m³/hr.)	4"	—	300 PSI (20.7 bar)	600	
320-U2	.752 GAL. (2.847 LITER)	450 GPM (102 m³/hr.)	6"	—	300 PSI (20.7 bar)	600	
370-U2	1.099 GAL. (4.160 LITER)	660 GPM (150 m³/hr.)	6"	—	200 PSI (13.8 bar)	600	

Rectangular Flange Model.

MODEL	DISPLACEMENT PER REVOLUTION	NOMINAL CAPACITY* TO	INLET/ W X L INCHES	OUTLET	PRESSURE RANGE UP TO**	MAXIMUM RPM	TEMP RANGE**
014-U2	.0142 GAL. (.054 LITER)	5.68 GPM (1.3 m³/hr.)	1.44x4.94	1 1/2"	250 PSI (17.2 bar)	400	Std. Rotors: (-40 ° F/C TO 200 °F (93 °C)
034-U2	.060 GAL. (.227 LITER)	24 GPM (5.5 m³/hr.)	1.81x6.48	2"	250 PSI (17.2 bar)	400	
064-U2	.153 GAL. (.579 LITER)	61 GPM (13.9 m³/hr.)	2.44x9.0	2 1/2"	300 PSI (20.7 bar)	400	
134-U2	.253 GAL. (.958 LITER)	101 GPM (22.9 m³/hr.)	3.19x9.38	3"	200 PSI (13.8 bar)	400	
184-U2	.380 GAL. (1.483 LITER)	152 GPM (34.5 m³/hr.)	3.28x11.25	3"	450 PSI (31.0 bar)	400	Hot Clearance Rotors: 180 °F (82 °C) TO 300 °F (149 °C)
214-U2	.502 GAL. (1.90 LITER)	200 GPM (45.4 m³/hr.)	3.45x12.70	4"	500 PSI (34.5 bar)	400	
224-U2	.521 GAL. (1.972 LITER)	208 GPM (47.2 m³/hr.)	4.06x11.25	4"	300 PSI (20.7 bar)	400	
324-U2	.752 GAL. (2.847 LITER)	300 GPM (68.1 m³/hr.)	4.25x12.70	6"	300 PSI (20.7 bar)	400	

*For capacities above 830 to 935 GPM, see bulletin FH-1725 on 420/520 UHC (ECP Rotors).

**Contact application engineering for higher pressure or higher temperature applications.

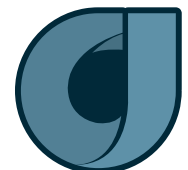

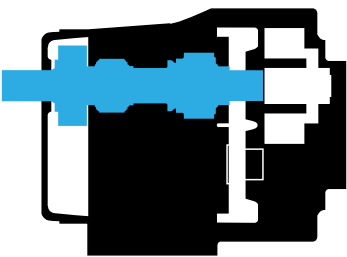
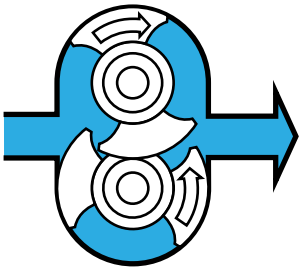
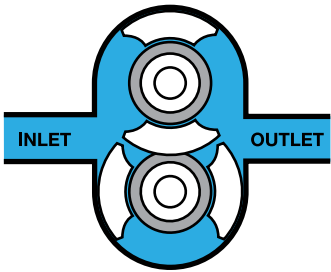
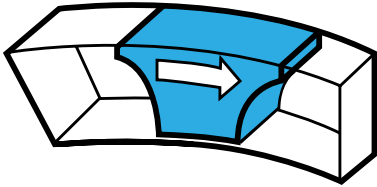

Time-tested Waukesha Cherry-Burrell rotary pump; circumferential-piston operating principle.

In the Waukesha Cherry-Burrell design, arc-shaped “pistons” (rotor wings) travel in annular-shaped cylinders machined in the pump body; the resulting long sealing path reduces slippage and produces a smooth flow of product without destructive pulses or pressure peaks and without valves or complex parts.

Exclusive Waukesha Cherry-Burrell design features

For low Viscosity Fluids, Rotors, made of exclusive Waukesha “88” alloy, can be run with close clearance to the 316 stainless steel fluid head, without galling or seizing should inadvertent pressure surges cause contact. The close clearances combined with the rotor geometry, which gives a long sealing path between the pump inlet and outlet, means low slip operation. As a result, you achieve: high efficiency, good priming ability, metering capability and good flow control.

For High Viscosity Fluids, the large fluid cavities of the rotors ... plus the large, easy entry anti-cavitation ports ... allow efficient pumping of high viscosity fluids, slurries or even liquids with large chunks or particles.

For Non-Lubricating and Abrasive Fluids, the unique Waukesha Cherry-Burrell design has no bearing in the fluid being pumped, no sliding or rolling contact and no rotor-to-rotor contact. This produces **MAXIMUM SERVICE LIFE** even under severe operating conditions.

Performance and Long Life Through Engineering.

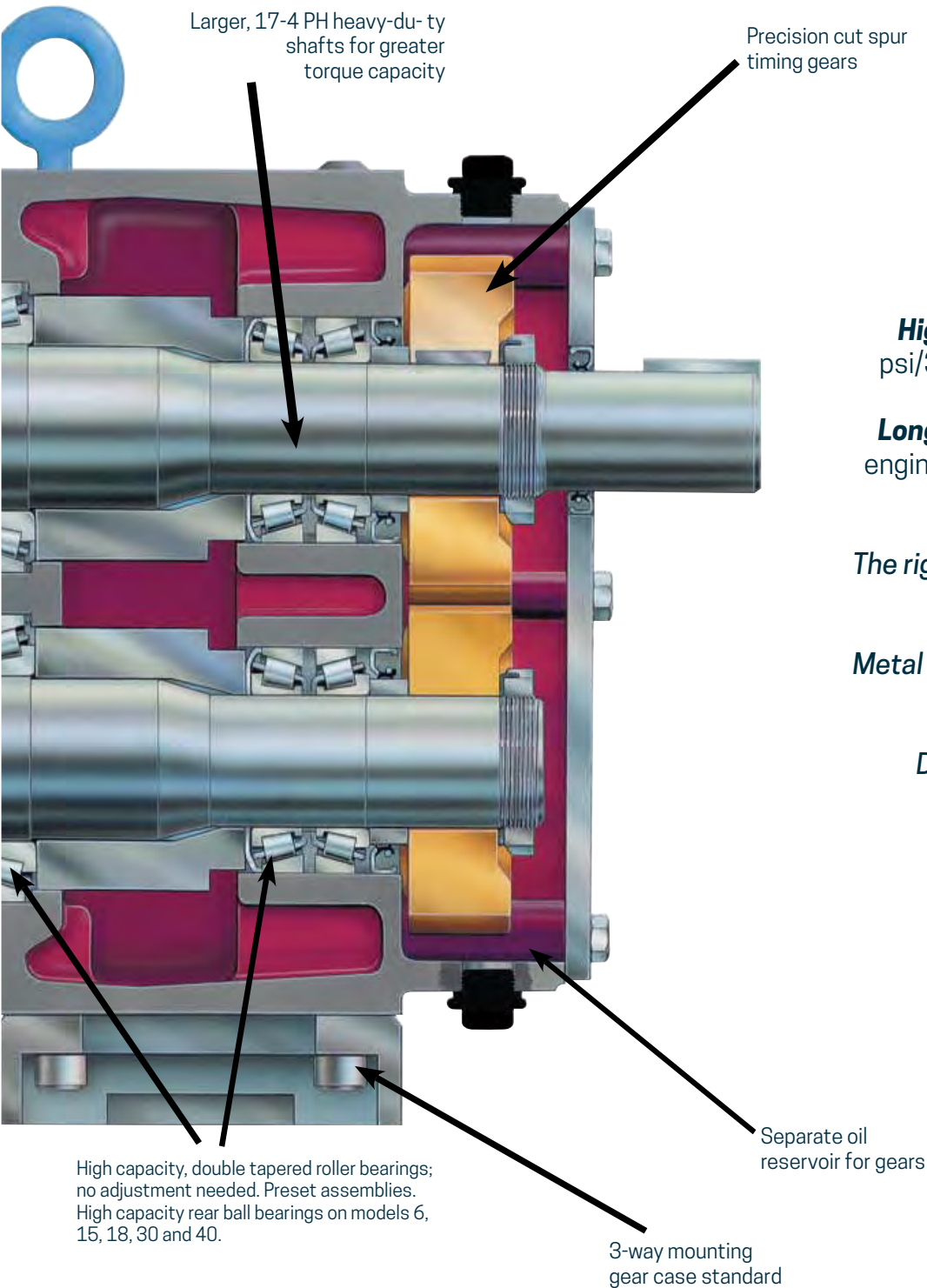

*The Waukesha Cherry-Burrell
Universal II Series gives you...*

High pressure capability: up to 500 psi/34.5 bar, for more demanding jobs.

Long service life: resulting from fresh engineering approach and high capacity components.

The right seal: for every application, plus interchangeability when needed.

Metal rotor: Waukesha "88" non-galling alloy, for close running clearance.

Design conforms: to 3A, USDA, ISO 9001:2000 and CE standards.

*For higher pressures, consult the factory.



Seal Options

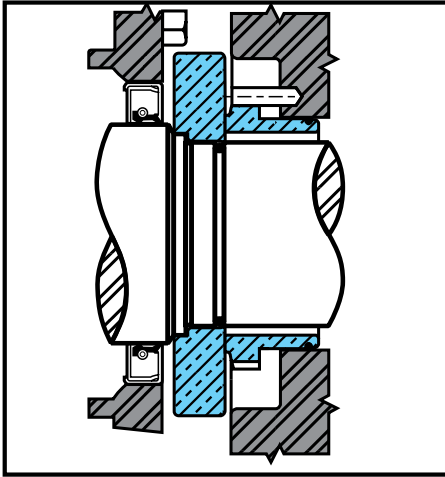

Double concentric Mechanical Seal †
 Used with flushing fluid to cool, lubricate, flush away residue. Best arrangement for severe service.

Single Mechanical Seal †
 Carbon-to-ceramic faces standard. Alternate materials available for abrasive service.

Elastomer choices for “O” rings:

- Buna-N
- Fluoroelastomer (FKM)
- EPDM
- Silicone
- Perfluoroelastomer (FFKM)
- PTFE Encapsulated

† Mechanical seal material options:

- Carbon
- Ceramic
- Silicon Carbide
- Tungsten Carbide



316 stainless steel; design conforms to 3A, USDA, BISSC, EHEDG, CE, ASME standards

Field Interchangeable seal options for every service

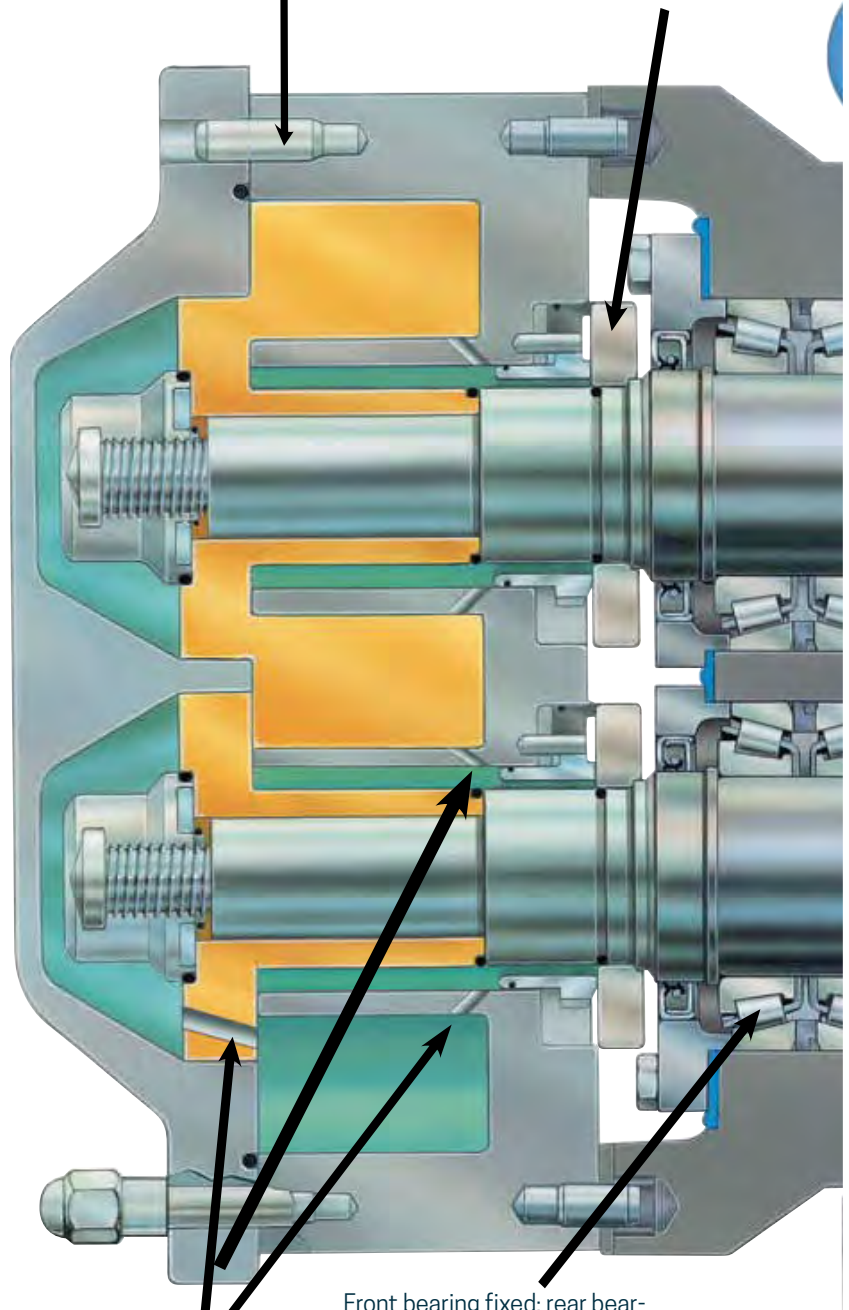

Optional drilling shown for CIP models

Front bearing fixed; rear bearing floating. Better control of thermal expansion when handling hot products

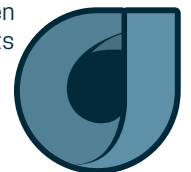

COEBSA

Standard & Options

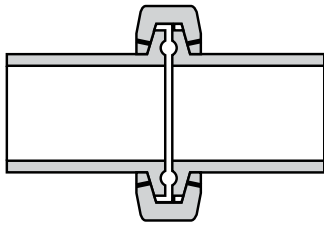

Standard Sanitary Clamp Type
Is available in a variety of styles
including S-Line, I-Line and Q-Line

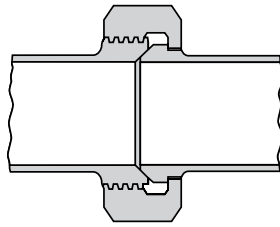

Bevel Seat
Available

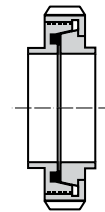

Optional European
Types; DIN, SMS,
RJT

**Male NPT and 150 lb. flanges optional on Models 006 through 220 size.
150 lb. flanges standard on Model 320.
Contact factory for available rectangular flange inlets.**

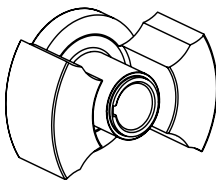

Twin Wing
Standard;
suitable for most
applications.

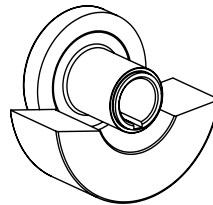

Single Wing
For minimum
breakage
on fluids with
discrete particles,
such as diced
tomato products.

Rotor Clearance
Standard for most applications up to 200°F.
Hot clearance rotors option for applications up to 300°F.
Other special clearances available.

Buna-N Standard
Optional: Fluoroelastomer (FKM), EPDM, Silicone, Per Fluoroelastomer (FFKM),
FEP Encapsulates.

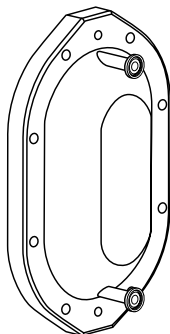

Optional drain and/or
vent connections



Shown with optional
3-wing cover nuts

Ports

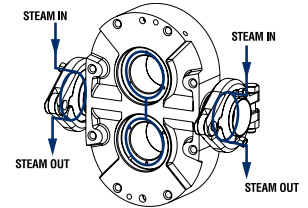

Optional
Aseptic Ports

Rotors

O-Rings

Cover & Gearcase

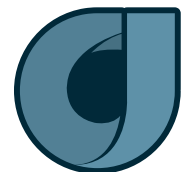

COEBSA

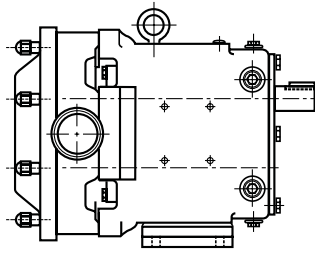

Top Shaft Position
Standard

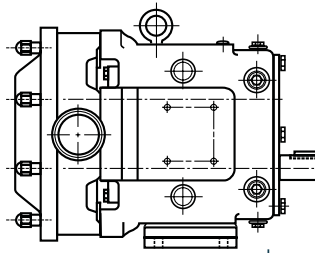

Lower Shaft Position
Optional

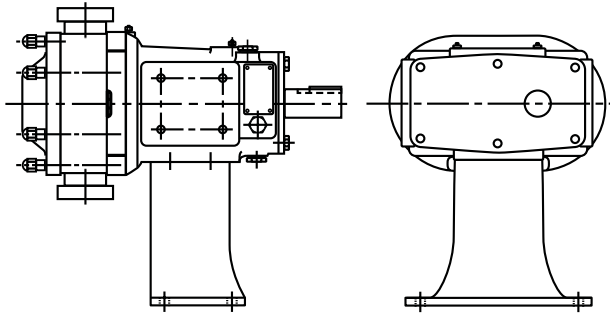

Optional Side Mount Gear Case for vertical fluid entry
and free draining of body

Standard left hand
shaft position shown
(right hand optional)

Flat plate, epoxy painted, with adjustable feet, SS coupling guard, and Lovejoy or Woods coupling standard.

- Options:
- 304 SS unpolished plate base with adjustable feet.
 - Portable base with rubber wheels.
 - SS tubular bases.

WCB ISR Integral Speed Reducer Sizes 49, 79 and 239.

Direct connected gear motors.

Mechanical and Electronic Variable Speed Drives.

Hydraulic Motor Drives.

Close coupled Tru-Fit™ pump mounted on Epoxy-painted open base.

- Features:**
- No shaft alignment necessary. No coupling guard required.
 - Special base design enhances cleanability.
 - Reduces overall length of complete unit by an average of 20-25%.
 - Average of 20-25 gear ratios available per horsepower.
 - Separate oil sump for gear reducer and timing gears

- Options:**
- 304 SS unpolished plate base.
 - 304 SS polished plate base.
 - NEMA or IEC frames available. Right angle reducer also available for additional space savings.
 - 1/2 through 60 horsepower drive options available.
 - Horizontal or vertical porting.

Shaft Position

Mounting

Bases and Drives

Tru-Fit

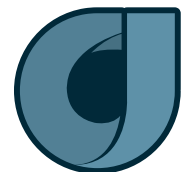
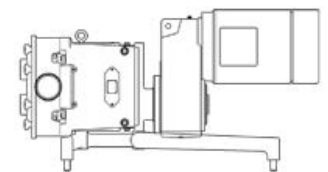

Dimensions

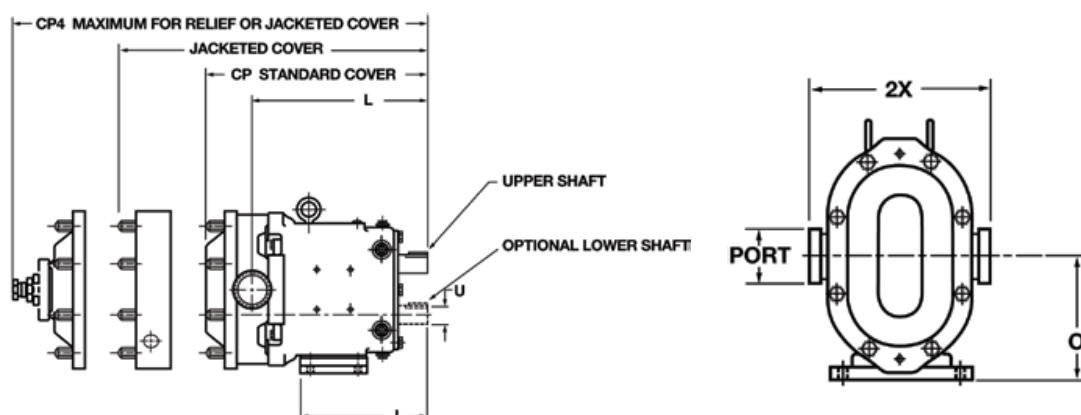

SIZE MODEL		CP	I	L	O	PORT SIZE	U +0.000 -0.001	2x	CP4
006-U2	IN	11.71	7.66	9.61	4.21	1"	.875	6.97	14.92
	mm	297	194	244	107	—	22.23	177	379
015-U2	IN	11.71	7.66	9.61	4.21	1 1/2"	.875	6.97	14.92
	mm	297	194	244	107	—	22.23	177	379
018-U2	IN	12.37	7.66	10.48	4.21	1 1/2"	.875	6.97	15.58
	mm	314	194	266	107	—	22.23	177	396
030-U2	IN	14.49	8.83	11.61	5.21	1 1/2"	1.250	8.50	17.58
	mm	368	224	295	132	—	31.75	216	447
040-U2	IN	14.87	8.83	11.99	5.21	2"	1.250	8.62	17.96
	mm	378	224	305	132	—	31.75	219	456
045-U2	IN	18.59	10.99	14.86	7.31	2"	1.625	10.75	22.28
	mm	472	279	377	186	—	41.28	273	566
060-U2	IN	19.14	10.99	15.14	7.31	2 1/2"	1.625	10.75	22.83
	mm	486	279	385	186	—	41.28	273	580
130-U2	IN	20.15	10.99	17.77	7.31	3"	1.625	10.75	23.84
	mm	512	279	401	186	—	41.28	273	606
180-U2	IN	23.26	14.80	18.25	9.38	3"	2.000	13.06	28.51
	mm	591	376	464	238	—	50.80	332	724
210-U2	IN	27.08	17.80	21.24	10.38	4"	2.375	14.73	—
	mm	688	452	539	264	—	60.45	374	—
220-U2	IN	24.00	14.80	18.49	9.38	4"	2.000	13.25	29.25
	mm	610	376	470	238	—	50.80	337	743
320-U2	IN	27.66	17.80	21.63	10.38	6" 150# FLG	2.375	16.00	—
	mm	703	452	549	264	—	60.45	406	—
370-U2	IN	29.16	17.80	22.32	10.38	6" 150# FLG	2.38	17.00	—
	mm	741	452	567	264	—	60.5	432	—



NOTE: Dimension "2X" applies for Bevel Seat, "S-Clamp", "Q-Clamp", 15l and 14l fittings on Models 006 through 220
 Dimension "2X" applies for 6" 150 lb. RF Flange on Model 320.
 Consult factory for available rectangular flange inlets.

NOTE: Dimensions are for guidance purposes only. Contact your WCB Representative if more detailed measurements are needed.

Universal II Series Rectangular Flange

SIZE MODEL		AO*	CP	CP4	I	PORT SIZE	U +0.000 -0.000	2x	WT LBS / KG
014-U2	IN	12.50	11.71	14.92	7.66	1 1/2"	.875	7.11	47
	mm	318	297	379	195	—	22.23	181	21
034-U2	IN	12.75	14.49	17.58	8.49	2"	1.250	8.12	100
	mm	324	368	447	216	—	31.75	206	45
064-U2	IN	13.94	19.14	22.83	10.77	2 1/2"	1.625	10.31	255
	mm	354	486	580	274	—	41.28	262	116
134-U2	IN	13.94	20.15	23.84	10.77	3"	1.625	10.31	280
	mm	354	512	606	274	—	41.28	262	127
184-U2	IN	35.94	23.26	28.51	13.74	3"	2.000	13.78	414
	mm	913	591	724	349	—	50.80	350	225
214-U2	IN	35.94	27.08	—	16.86	4"	2.375	16.17	759
	mm	913	688	—	428	—	60.33	411	345
224-U2	IN	19.75	24.00	29.25	13.74	4"	2.000	12.87	505
	mm	502	610	743	349	—	50.80	327	229
324-U2	IN	35.94	27.66	—	16.86	6"	2.375	17.81	775
	mm	913	703	—	428	—	60.33	452	352

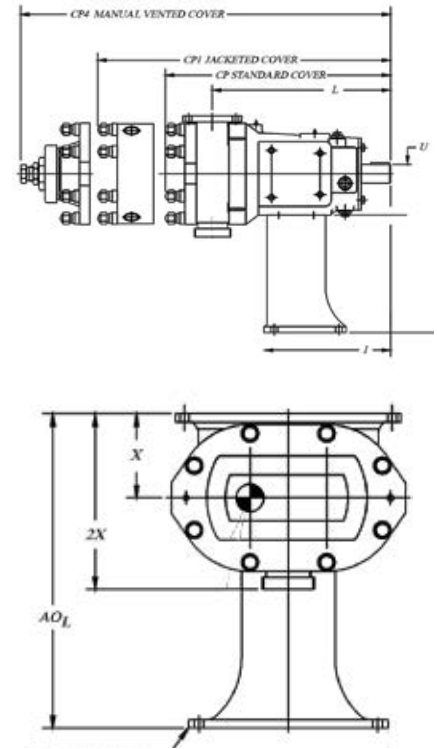

NOTE: Dimensions are for guidance purposes only. Contact your WCB Representative if more detailed measurements are needed.
Optional Pedestal sizes are available please contact factory for more details.

Universal II Series Tru-Fit™

SIZE MODEL		A	AO	H	M	PORT SIZE	N	O
006-U2	IN	12	13.25	18	27.31	1 1/2"	15.56	9.15
	mm	305	37	457	694	—	395	232
018-U2	IN	12	13.25	18	27.31	1 1/2"	15.56	9.15
	mm	305	37	457	712	—	395	232
030-U2	IN	14	15.11	20	33.57	1 1/2"	18.65	10.02
	mm	356	384	508	853	—	474	255
040-U2	IN	14	15.11	20	33.94	2"	18.65	10.02
	mm	356	384	508	862	—	474	255
045-U2	IN	18	20.00	28	43.72	2"	22.02	12.00
	mm	457	508	711	1112	—	559	305
060-U2	IN	18	20.00	28	44.00	2 1/2"	22.02	12.00
	mm	457	508	711	1118	—	559	305
130-U2	IN	18	20.00	28	45.01	3"	22.02	12.00
	mm	457	508	711	1143	—	559	305
180-U2	IN	20	23.25	36	50.02	3"	25.91	14.50
	mm	508	591	914	1270	—	658	368
220-U2	IN	20	23.25	36	50.76	3"	25.91	14.50
	mm	508	591	914	1289	—	658	368

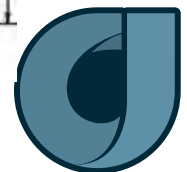
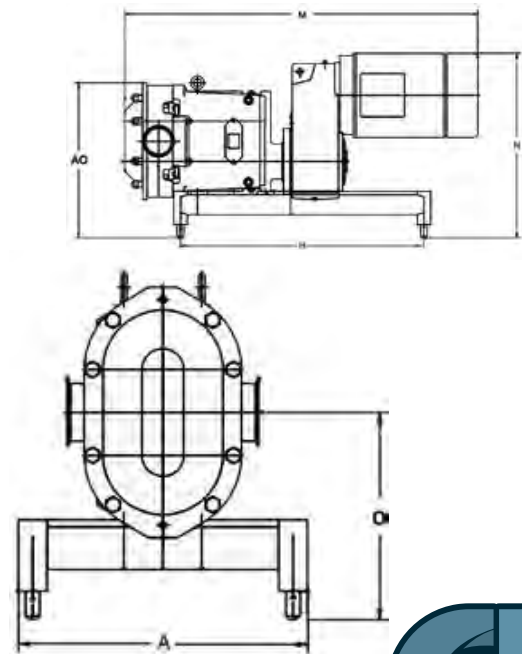

When it is time to repair ...

Waukesha Cherry-Burrell offers the following options – you pick the one that meets your needs.

Factory Remanufacturing Program – WCB traditional program

- No need to return your pump until you receive your new replacement pump.
- Substantial savings over new pump.
- All remanufactured pumps must pass a 25 point inspection process and undergo performance testing.
- Only OEM genuine parts are used in the remanufacturing process and you receive a guaranteed warranty and quality certificate with each pump.
- New pumps eligible for Remanufacturing Program twice.
- See Bulletins FH-1728 and FH-1871 for more details.

Factory Inspect and Advise Program

- Return your pump for complete factory inspection.
- Cost effective options to match your performance/budget needs.
- Your pump body may be remachined up to 6 times.
- Replacement rotors and parts available.
- Factory warranty.
- See Bulletin FH-1728 for more details.

WCB Certified Pump Repair Centers

- Local distributors with factory trained and certified service technicians.
- Quick local response.
- Genuine WCB parts.
- Flexible repair programs to meet your needs.
- Local warranty.

Waukesha cherry-Burrell Warranty

Seller warrants its products to be free from defects in materials and workmanship for a period of one (1) year from the date of shipment. This warranty shall not apply to products which require repair or replacement due to normal wear and tear or to products which are subjected to accident, misuse or improper maintenance. This warranty extends only to the original buyer. Products manufactured by others but furnished by seller are exempted from this warranty and are limited to the original manufacturer's warranty.

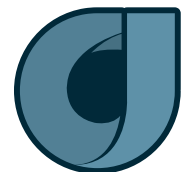

COEBSA



www.coetsa.com.mx